

**Anschlußschema VDDH - Schnittstelle Code A**

Rückmeldeleuchte im Fahrerhaus leuchtet bei geöffnetem Plattform und eingeschalteter Zündung !!!

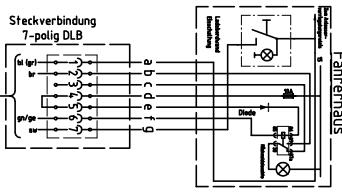

**Anschlußschema original Dautel - Fahrerhauseschaltung**

Die Ein - Aus / Rückmeldeleuchte leuchtet bei eingeschalteter Fahrerhauseschaltung und / oder geöffnetem Plattform bzw. ausgefahrenen Stützzyllindern

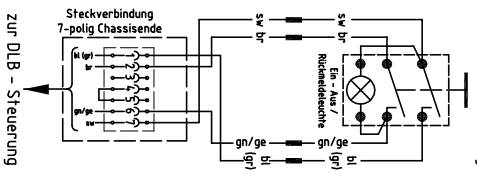

DAF	Serie	MAN	Daimler-Chrysler
SILCO/2927	EV.Nr.:22122	Code: 320LEC	Code: E 33
a = 6197	a = blau	a = 9136	a = blau
b = 6035	b = grün	b = 9137	b = blau
c = 6036	c = gelb	c = 9138	c = blau / gelb
d = 6258	d = weiß	d = 9003	d = schwarz / blau / rot
e = 6168	e = gelb	e = 9157	e = braun / lila
f = 6169	f = braun	f = 9155	f = rot / grün
g = 6164	g = rot	g = 9155	g = rot / grün
Diode = Ja	Diode = Ja	Diode = Nein	Diode = Ja

**Anschlußschema Fahrerhauseschaltung Veco Euro Cargo SW 4113**

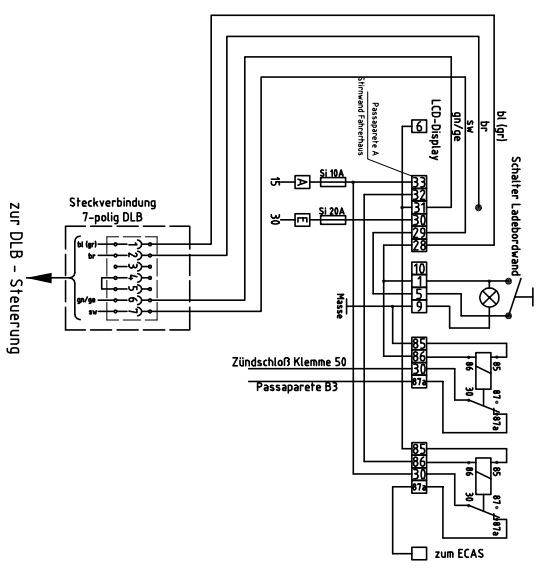

**Codierschalter Bedieneinheit**

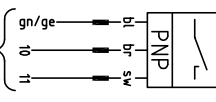

**Aggregat bzw. Tragrohr**

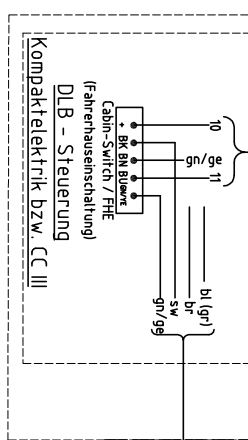

**Steckdose Zugfahrzeug 432 Th**

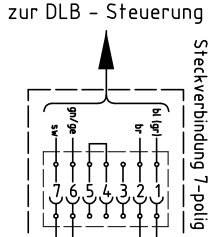
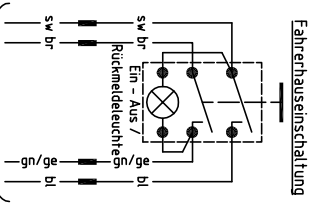
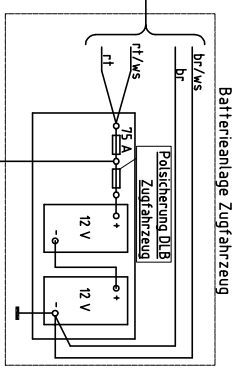
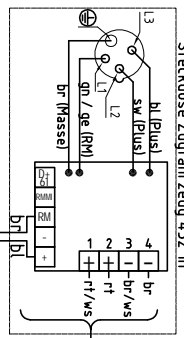

**Anschlußschema Dautel - Ladeleitung, Motorwagen ohne DLB**

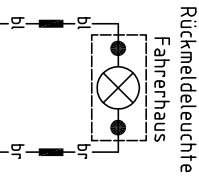
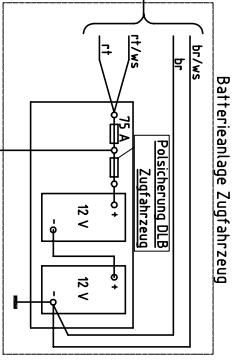
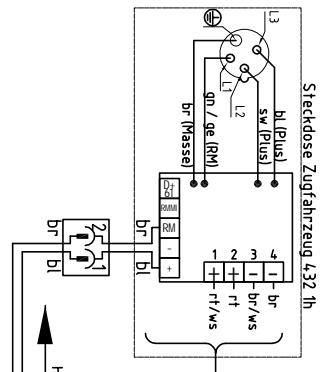

**Anschlußschema Dautel - Ladeleitung Anhänger / Sattelaufleger**

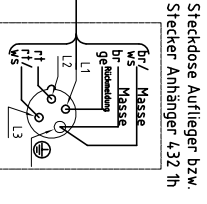
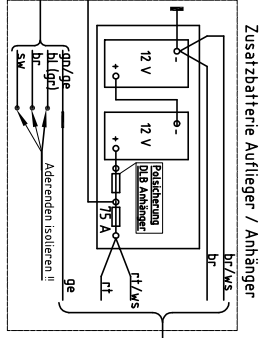
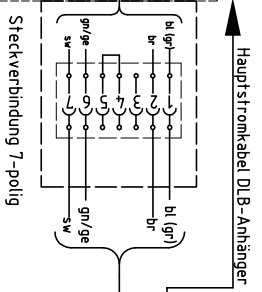

Nr.	Datum	Version	Abgezeichnet
	10.03.04	sid	
ZUSATZELEKTROSCHAL PLAN			
THEMENSCHÜTLÜNGEN RM ARBEITSTRONPRINZIP			
Zeichnungs-Nr.	Blatt-Nr.	Blatt-Zahl	Blatt-Gesamt
0081704	03	2	2
DAUTEL		Fsk-Nr. 50200	